

HOBART

WAREWASHING

FLIGHT-TYPE DISHWASHERS **FLOW** Line



100% OF REQUIREMENTS

1 SOLUTION



IS

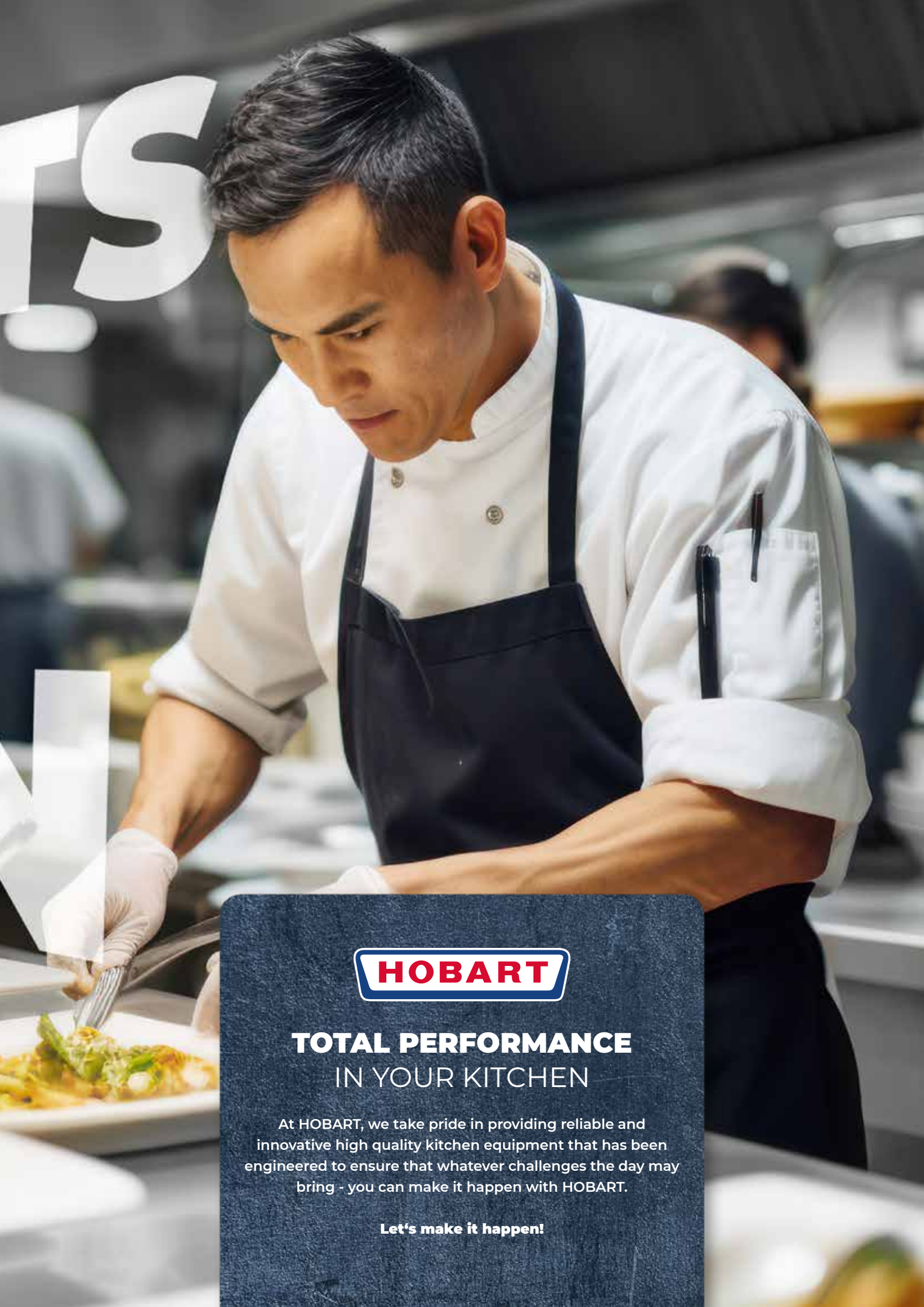

HOBART

**TOTAL PERFORMANCE
IN YOUR KITCHEN**

At HOBART, we take pride in providing reliable and innovative high quality kitchen equipment that has been engineered to ensure that whatever challenges the day may bring - you can make it happen with HOBART.

Let's make it happen!



HOBART

7 MARKETS

Countless challenges

1 SOLUTION

FLIGHT-TYPE DISHWASHERS **FLOW** Line



HOSPITALITY

Bar & Pub / Bistro & Café /
Hotel & Restaurant



FOODSERVICE

Hospital / Nursing Home /
Canteen / Education - School & University



BAKERY

Bakery subsidiary / Production / Bakery industry



MEAT PRODUCTION

Butchery / Meat production industry



INDUSTRY



GLOBAL MARINE



AIRLINE CATERING





FLOW Line

SMOOTH PROCESSES IN YOUR SCULLERY

Every professional kitchen is looking to ensure a perfect FLOW in the scullery. Our technology helps you to provide it every day for you and your kitchen team. A perfect FLOW means to have all processes running smoothly so that everyone involved can concentrate on their tasks without interruption. When AI-supported warewashing technology meets smart automation solutions, the perfect FLOW is pre-programmed - true to our motto "Work smart, not hard!"

MOST EFFICIENT FLIGHT-TYPE DISHWASHER IN THE MARKET

The FLOW Line combines a high level of economy and best wash results with extremely comfortable cleaning. A number of innovative features (**PREMAX** inside) ensure that the warewashing process runs smoothly and perfectly hygienic at all times, and that your employees have

no problems operating and cleaning the machine. Benefit from the significantly reduced operating costs every day in your ongoing operation.

With its modular design, the FLOW Line flight-type dishwasher series can be tailored to your requirements. Pre-wash, main wash, drying and intermediate zones are planned individually for each customer - depending on the wash volume. In this way, we ensure that performance, efficiency and ease of use are optimally tailored to your requirements and your organisation.



FLOW Line

UNIQUE AI-SUPPORTED WAREWASHING TECHNOLOGY

The new FLOW Line is a power package for your kitchen and ensures that everything runs smoothly – with a perfect flow.

Many new features and the innovative technology ensure faster work processes and reduce the number of man hours required. What's best: The FLOW Line is the first flight-type dishwasher that uses artificial intelligence to support your warewashing activities – boosting the economic efficiency of your enterprise!

AI-based features such as SMART VISION CONTROL and ASR² set new standards in terms of warewashing intelligence. This allows you to wash even more efficiently and save resources every day,

which significantly reduces your ongoing operating costs.

Choose from a variety of optional performance packages to increase your warewashing efficiency even further – independent of who operates the machine. Washing and rinsing parameters and the conveyor speed are automatically adapted to the requirements of the respective wash ware, reducing consumption to a minimum. Another valuable benefit: the significant reduction in time-consuming manual labour.



PREMAX inside

EVEN MORE EFFICIENCY AND SAVINGS

It's the ongoing operating costs of a dishwasher that make the difference! The optional **PREMAX** inside features make the FLOW Line the most economical flight-type dishwasher on the market. The three **PREMAX** inside features

CLIMATE-PRO heat pump, **LOW-FLOW** rinse system, or the **LCI** detergent saving system provide significant additional savings of energy, water, and chemicals while ensuring premium wash results.



SMART VISION CONTROL



SMART VISION CONTROL

Wash ware detection via artificial intelligence

Heavily soiled wash ware such as GN containers or pots require more intensive washing than plates or cups. By means of AI, the FLOW Line recognises the wash ware as soon as it is placed on the conveyor. If equipped with the respective performance package, it continuously adjusts the wash and rinse parameters such as conveyor speed, water volume and wash pressure. SMART VISION CONTROL guarantees optimum wash results with minimum water consumption - regardless of who is operating the machine.

This innovative AI feature ensures guaranteed hygiene while compensating for partially loaded dishwashers: If conveyor sections remain empty, the water consumption is automatically reduced to a minimum. Furthermore, the water consumption is adjusted to the respective conveyor speed so that the same amount of water is applied to the wash ware at all times.

AI TECHNOLOGY

Deep Learning in the scullery

The FLOW Line software has been trained with data of more than 80,000 pictures. The neuronal networks generated during this process identify the incoming wash ware within fractions of a second and immediately adjust the respective wash parameters accordingly.

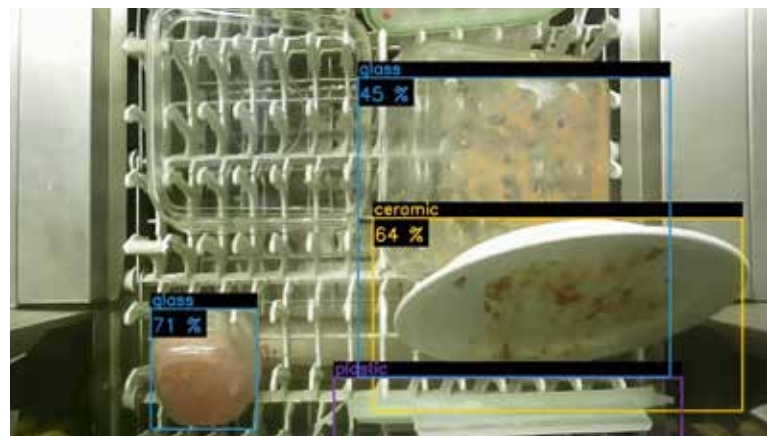

WASHING INTELLIGENCE AT A NEW LEVEL

PERFORMANCE PACKAGES

For even more savings

In addition to the optical detection installed as standard, we offer optional performance packages that further reduce the machine's consumption and increase operating safety. Thus, you can achieve the best wash result with the most economical processes at all time - independent of who operates the machine and of the amount of wash ware.

PERFORMANCE PACKAGE

Perfect wash parameters

By means of the AI-based Performance Package, the system continuously adjusts the parameters for glasses, cutlery and wash ware made of metal. If, for example, a rack of glasses is placed in the machine, the system increases the fresh water rinse and simultaneously reduces the conveyor speed. No manual settings are required for this adjustment.

Another benefit: There is no more need for time-consuming pre-cleaning of heavily soiled wash ware because the wash and rinse parameters and the conveyor speed are automatically adjusted to the requirements of the wash ware. This furthermore keeps consumption to a minimum.

PERFORMANCE PLUS PACKAGE

More soil, higher wash pressure

When the Performance Plus Package is in place, the machine operates at a higher wash pressure when loaded with cutlery, heavily soiled pots or GN pans. This ensures the best possible wash result for heavily soiled wash ware

and significantly reduces the need for time-consuming manual work. Even inexperienced operators make no errors because the system makes all required adjustments.

PERFORMANCE	PERFORMANCE PLUS
Glass programme	Glass programme
Cutlery programme	INTENSIVE ² cutlery programme
Pots & pans programme	INTENSIVE ² pan programme



LCI DETERGENT SAVING SYSTEM



Continuous monitoring of the wash water is the basis for need-based chemical dosing



LC DETERGENT SAVING SYSTEM

Reduced detergent consumption – easy on the wallet

The total fresh water volume is divided up, and the LC detergent saving system directs just 75 l of fresh water into the wash tank for regeneration of the wash water. Only this low quantity is directed into the main wash and mixed with detergent. Detergent dosing depends on the fresh water volume, which means you save on a corresponding amount of chemicals. The remaining water is directly pumped into the pre-wash tank via a bypass line.

The benefit

Reduce your detergent consumption by up to 50 % compared with conventional systems.

PREMAX inside

LOW-FLOW RINSE SYSTEM

Particularly effective water saving

The new LOW-FLOW rinse system is super-economical and ensures perfect wash results: precision nozzles arranged at an inclined position and the fine atomisation of the fresh water in combination with an upstream drip section can reduce water consumption by 40 %.

PREMAX inside

LCI DETERGENT SAVING SYSTEM

Cleaning chemicals: use only as much as you need

Lower chemical consumption means reduced operating costs for you whilst also protecting the environment – the newly developed optional LCI detergent saving system makes this possible.

And this is how it works:

A sensor in the wash tank continuously checks the quality of the wash water and regenerates it as necessary. Depending on the degree of soiling, water from the rinse is briefly fed into the main wash tank as required. The chemical dosing is adjusted to the tank regeneration.

Your benefits at a glance in comparison to the LC detergent saving system

- Reduction of your detergent consumption by up to 30 % compared to LC detergent saving system.
- Automatic chemical dosing, precisely as needed.
- Optimal wash water quality guarantees best wash result.

OPTIMAL WASH WATER QUALITY

ASR² AUTOMATIC SOIL REMOVAL

Optimum wash water thanks to AI

High levels of soil in the entry section of the machine result in high water and chemical consumption. The AI-based feature ASR² identifies the degree of soiling of the wash ware in the machine and adjusts the pumping cycle accordingly.

Coarse soil is automatically pumped out of the pre-wash zone as required and transported to the strainer drawer at the entry section. This guarantees consistently high wash water quality and eliminates the need to change the water between dishwashing shifts.

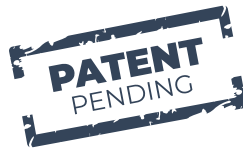

Your benefits at a glance:

Complete a long day of dishwashing without having to change the water, but achieve a hygienically clean wash result – even when there is extreme soiling.

- Individual soil pumping as required is guaranteed.
- A consistently high wash water quality is maintained.
- Wash tanks need to be emptied and filled with fresh water less often.

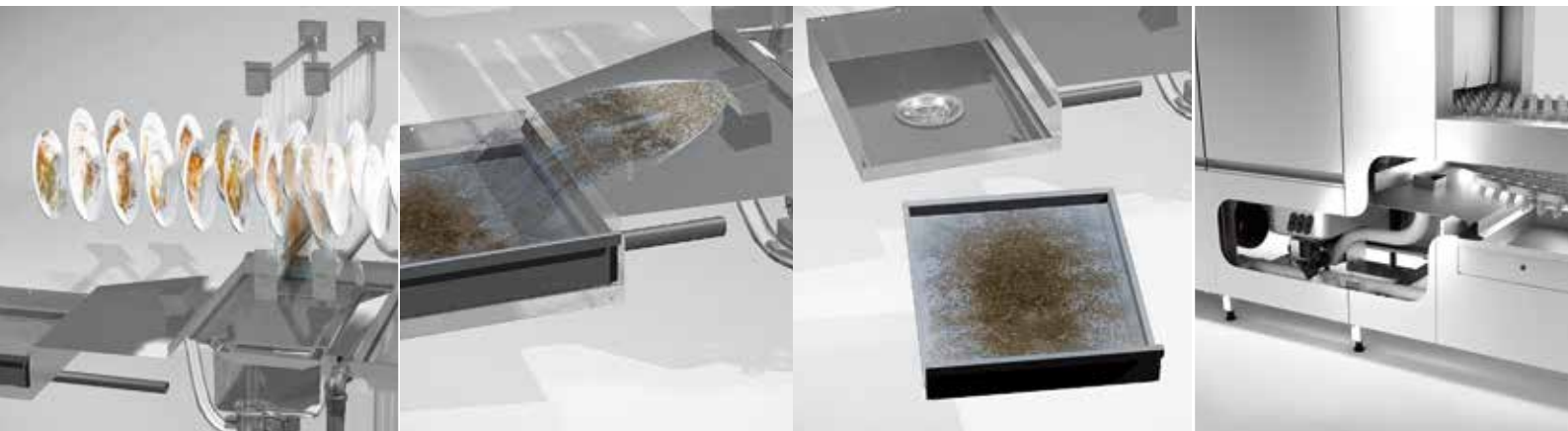



REDUCING ENERGY CONSUMPTION

HEAT RECOVERY SYSTEMS

For the efficient use of energy

Saving energy with the system! Via the two optional features CLIMATE heat recovery or CLIMATE-PRO heat pump, the energy from the exhaust air is returned to your machine. This smart innovation not only lowers your operating costs but also protects the environment.

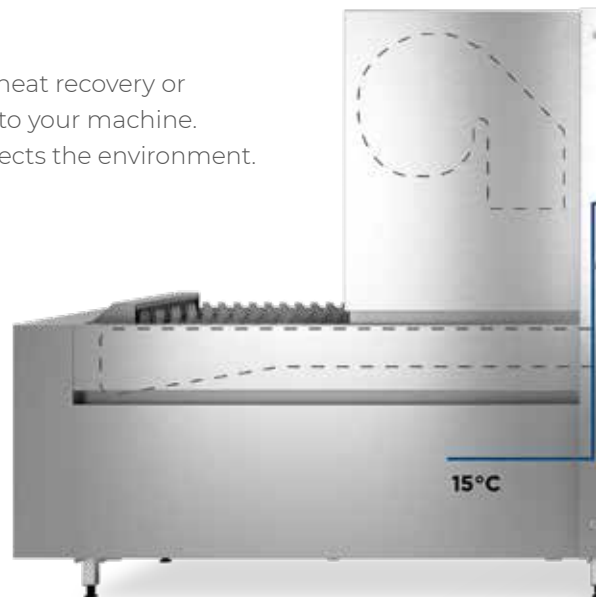
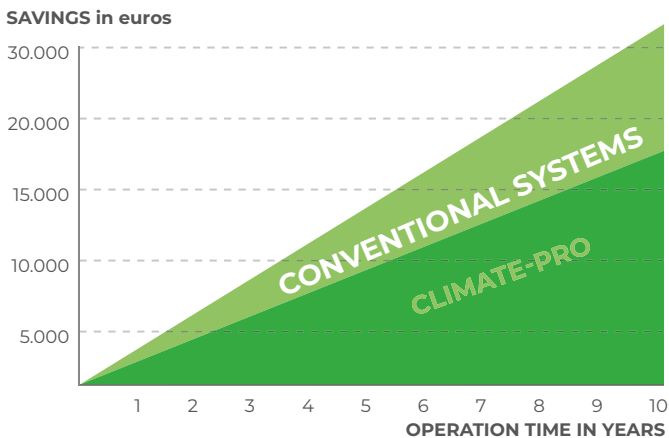

PREMAX inside

CLIMATE-PRO HEAT PUMP

Innovation meets economy and energy efficiency.

You can save up to 20 kWh with the CLIMATE-PRO heat pump.

Efficient energy management

The thermal energy contained in the exhaust air is completely regenerated by means of state-of-the-art technology and returned to the wash process and now also to the drying process. This not only helps you to reduce the energy consumption of your machine but also to save on the related operating costs.

By the way

As a result of constantly low exhaust air temperatures of 17°C, the room climate is improved in compliance with VDI 2052.

CLIMATE HEAT RECOVERY

Smart use of exhaust air

This feature minimizes energy losses via the warm exhaust air by continuously returning it to the system via a heat recovery system and pre-heating the fresh water before it runs into the boiler. Savings of up to 10 kW/h are possible in this manner.

Your benefits

- Minimised energy loss via exhaust air.
- Efficient use of the energy provided.
- Your machine's operating costs are significantly reduced.

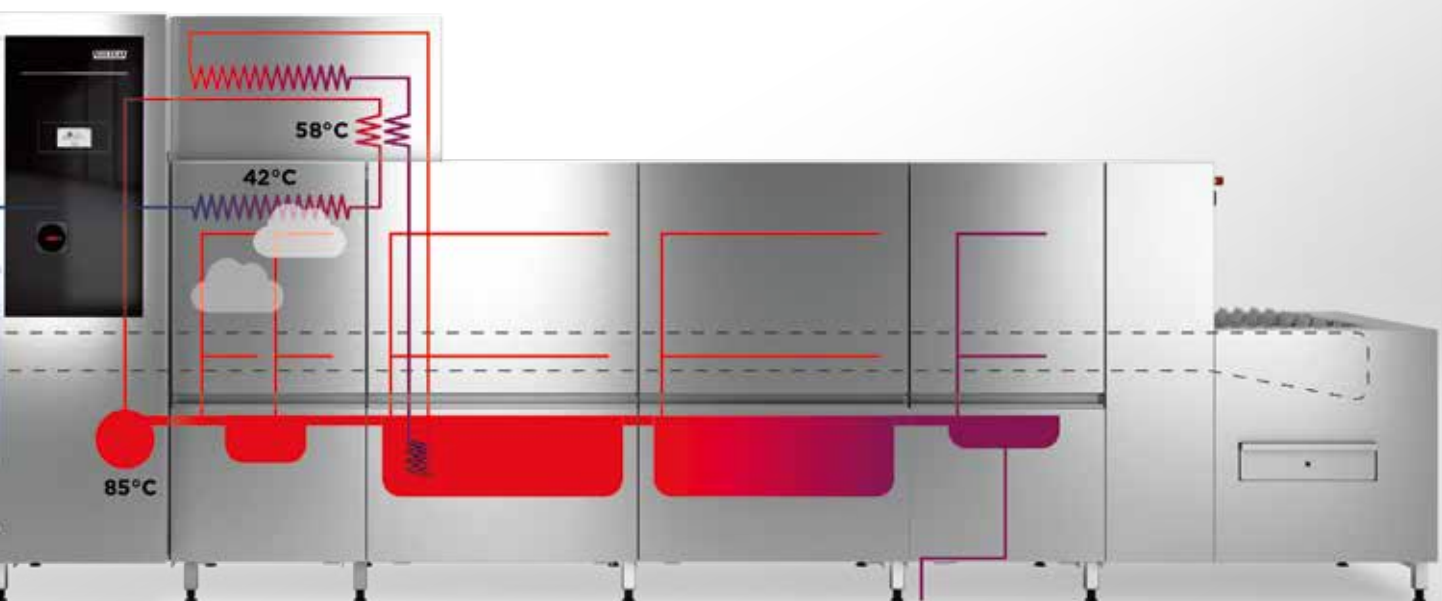

BEST WASH AND DRYING RESULTS

WASH SYSTEM WITH WIDE-ANGLE NOZZLES

Perfect cleaning of every nook and cranny

During the washing operation, an even distribution of the wash water on the wash ware is essential to achieve a perfect wash result. Innovative wash arms with special precision nozzles allow the wash water to come into prolonged contact with the wash ware and provide for an improved wash result.

Thanks to their special layout, the HOBART wash nozzles cover a larger area and target their spray more accurately than traditional systems.

Your benefit

The even and compact distribution of the wash water on the wash ware provides for a significantly improved wash result.

CONVEYOR BELT WITH TRAY SUPPORT

Avoids unsprayed areas

A perfectly hygienic wash result takes top priority when washing dishes, glasses or cutlery – the position of the wash ware in the machine is one of the key factors in this regard. Due to its special design, the conveyor belt with tray support ensures that the wash water is brought into optimum contact with the wash ware.

Because

A tray on a conventional conveyor belt can shield a following plate so much that the latter is not sprayed with an adequate amount of detergent solution.

TRIPLE RINSE

Perfect wash results without any residues

Soil particles or streaky detergent residues on supposedly clean plates are extremely off-putting. Enjoy guaranteed hygiene at all times with FLOW Line! After the washing process, the FLOW Line feature applies triple power to ensure residue-free and perfectly clean wash ware: pre-rinse nozzle, pumped rinse and fresh water rinse.

The new pre-rinse nozzle upstream of the pumped rinse rinses the wash water off the wash ware. Next, the pumped rinse provides the second rinse-off, followed by a final rinse with fresh water.

For you this means

A perfect result – because the wash ware passes through three stages of rinsing.



ALL-AROUND DRYING SYSTEM

Dryness for all types of wash ware

A conventional drying function blows the warm air onto the wash ware from above. As a result, the air is distributed in an uncontrolled manner. The all-around drying system not only directs air onto the wash ware from above, but also from the side and from the bottom. This ensures a perfect drying result even for hollow bodies.



RO-L REVERSE OSMOSIS SYSTEM

Eliminates water stains before they appear

Unightly stains on glasses, plates or knife blades? Minerals in water often leave visible residues when dishes are dried, thus creating a poor impression.

Put an end to tedious manual polishing

Reliable, stain-free, and hygienic: Continuous treatment with state-of-the-art membrane and filter technology ensures fully demineralised water. This permanently provides for hygienically clean wash ware without any stains. Hygienic risks

as a result of manual polishing are prevented in advance.

By the way

The RO-L reverse osmosis can be set up in a separate housing next to the FLOW Line, or integrated in its housing if a small footprint is of importance.

EASY HANDLING

VISIOTRONIC CONTROL

Full overview on the 5 inch screen

The modern full-touch control with colour display and intuitive menu navigation ensures fast, uncomplicated operation, even for inexperienced kitchen staff.

The big 5-inch display with its clearly arranged user interface is compact, convenient and can be read from anywhere in the room. All key information on operating modes, status and temperatures are shown clearly and concisely.

At a glance, the user gets an overview of the machine status and can intervene if necessary.

Intuitively understandable for everybody, the programme progress is displayed in LED bars:

- Standby (green)
- Washing active (blue)
- Error (red)

The display also offers intuitive access to the customer menu and to key data, such as:

- the documentation of the maintenance history compliant to DIN
- the indication of the water and power consumption
- the flexible programming of the autostart programme

The standard USB interface allows you to download data.



PROTRONIC XL CONTROL

Maximum user comfort

This control offers all the benefits of the VISIOTRONIC but has a much larger 7 inch display. In size XL, it ensures maximum user comfort.

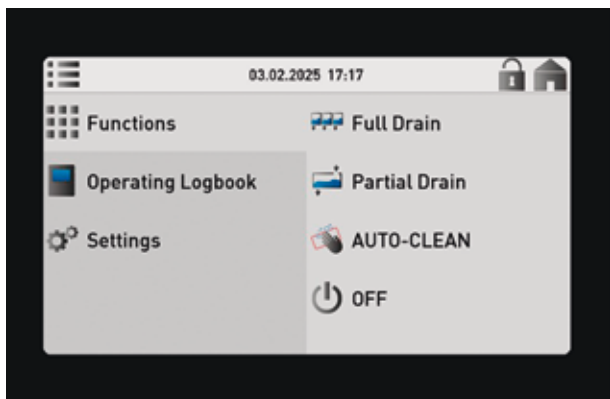
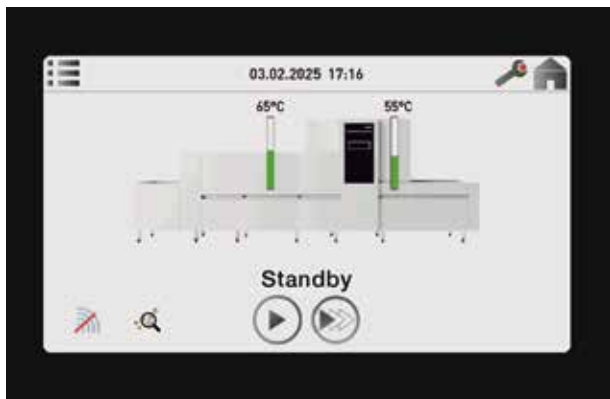

SYSTEM CHECK PACKAGE

Smooth start of work

Once the machine is switched on, this optional feature checks the main systems of the machine: wash system, drain valves, heaters, and strainer baskets. If there is a malfunction, the display will show the fault and the corrective measures in a clearly understandable manner. Thus, each work day starts smoothly and reliably. Also, the need to call in service technicians is reduced to a minimum.

CLEANING

AUTO-CLEAN SELF-CLEANING SYSTEM

Smart soiling management

Hygiene is the key factor when handling glasses, cutlery and dishes. For this reason, thorough cleaning of the dishwasher at regular intervals is essential. Thanks to the comprehensive cleaning assistance of the AUTO-CLEAN system, the daily cleaning routine of a dishwasher has never been easier or faster.

And, as you very well know, the easier the cleaning, the higher the probability that the staff will do it every day. This not only ensures reliable hygiene but also increases machine power and useful life.

The sophisticated arrangement of the dedicated cleaning nozzles ensures automatic cleaning of the machine interior and the heat recovery system. To guarantee that the highest hygiene standards are met, only fresh water is used for cleaning.

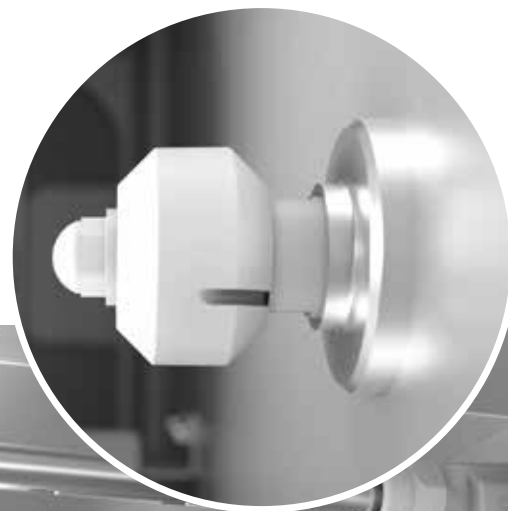



With the following standard features, the conveyor dishwashers saves much time while ensuring guaranteed hygiene:

ENTRY SECTION FLAP

Flap up, soil out

Most food residues build up in the machine's entry section. The folding entry section cover allows the machine to be accessed quickly and makes for straightforward cleaning.

COMPLETELY MOULDED TANK

No chance for residual soil

The design of tank sump and tank bottom does not offer soil any chance of depositing. Thus, soil cannot build up in the machine, and perfect hygiene is permanently guaranteed.

STRAINER DRAWER IN THE ENTRY SECTION

Quick and easy cleaning without interruption of the washing process

The strainer drawer can be easily removed so that accumulated food debris can be emptied quickly and effortlessly – even while the machine continues to wash.

By the way

The large collection volume and a high rim prevent the food debris from spilling over.

The strainer drawer can optionally be integrated at the face or front of the machine entry section.





CLEANING

The following additional features support the operator in addition to the patented AUTO-CLEAN self-cleaning system:

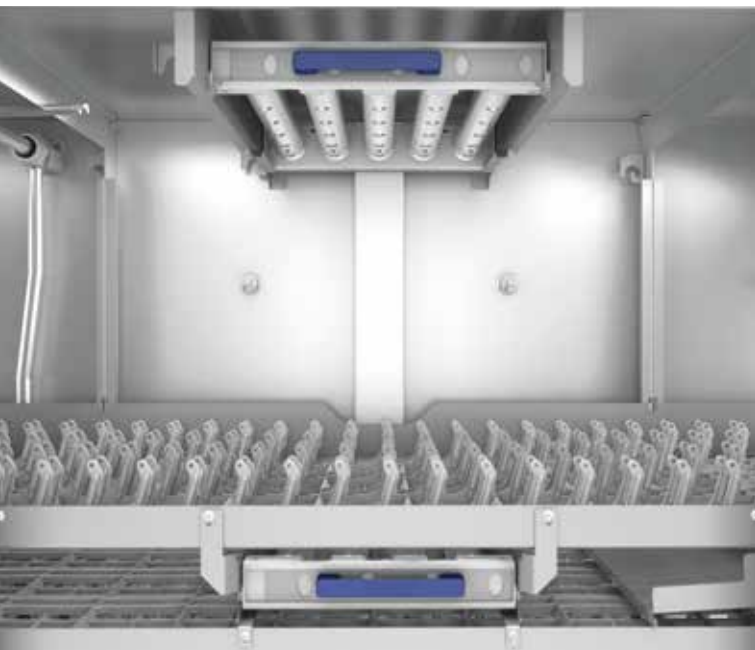

PATENTED WASH ARM SLIDERS

Quickly ready for cleaning

Our patented wash arm sliders allow you to clean the interior of the wash arms easily and comfortably. While conventional systems required you to unscrew the end caps of the wash arms first, now a single step is sufficient to get to the wash arm opening.

Combined with AUTO-CLEAN, the wash arm sliders ensure 100 per cent guaranteed hygiene since the wash arms are included in the cleaning. Opening the wash arm sliders is shown as a prompt on the display and must be acknowledged actively.

UNIVERSAL CURTAIN SYSTEM

One for all

After cleaning, all removed parts must be returned to their correct position. The universal curtains that fit everywhere in the machine make this task particularly comfortable. The hanging mechanism is extra-easy to handle and makes cleaning even faster. Thanks to the universal curtains, there is no risk of misplacement, and the job is done very quickly.



RINSE MODULE

Numbers for more clarity

The rinse module has been further improved to provide an optimum overview and therefore even faster and easier cleaning. The key element are the numbered wash arms that are swiftly replaced at the correct position.

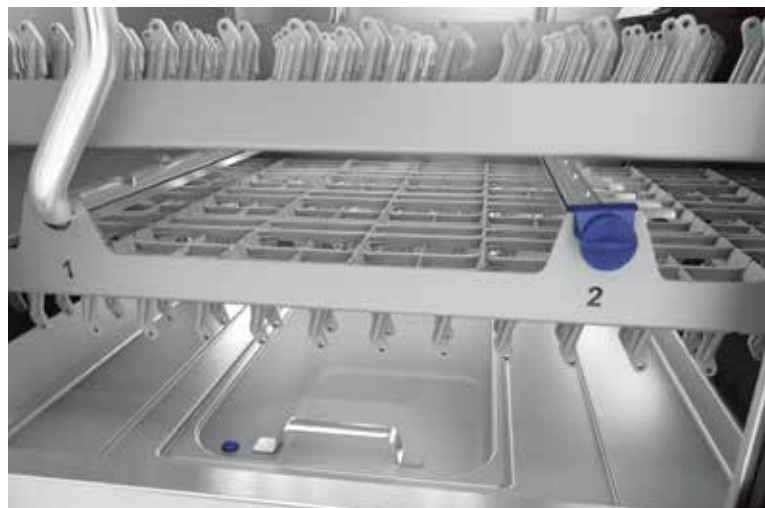

COLOUR-CODED CLEANING ASSISTANCE

Orientation for cleaning

To make machine cleaning extra easy, all elements that need to be removed for daily cleaning are equipped with a blue mark. Daily cleaning of your FLOW Line increases the performance and service life of your dishwashing system.



HOBART

HOBART



FLOW Line Twin

FLIGHT-TYPE DISHWASHER WITH INTEGRATED TRAY TRACK

Highest efficiency and perfect organisation

Flight-type dishwashers are designed for the fast cleaning of large quantities of wash ware items. With the innovative FLOW Line Twin dishwashing organising system, which is unique worldwide, HOBART caters for the practical demands in the food service industry with a tray system solution.

The world-leading, patented FLOW Line Twin dishwashing organising system significantly boosts machine capacity and optimises organisational processes. Bulky trays run on the separate round belt conveyor at the same time as the rest of the wash ware and are automatically destacked in the exit section of the machine.

Your benefits

- Up to 30 % faster thanks to the FLOW Line Twin dishwashing organising system.
- Reduce operating costs.
- Reduce operator burden thanks to automation.



HOBART

HOBART

HOBART
SMART
CONNECT

SMARTCONNECT



HOBART SMARTCONNECT APP

Key features at a glance

The new HOBART SmartConnect app provides you with a comprehensive overview of the status of your dishwasher – free of charge for 5 years.

Connect, learn, benefit

Based on this data, you can avoid downtime and contact HOBART customer service or an approved service partner. SmartConnect also provides illustrated instructions for minor malfunctions so that you can rectify them yourself.

An overview of all functions

- Machine status (keep up-to-date regarding the statuses of all your machines)
- Machine information (with all important settings and machine information)
- Recording of error messages (in addition, you will be notified by email concerning any system errors)
- Operating costs calculator (overview of the consumption costs)
- Hygiene information (as a log book)
- Operating cycles (information about the efficient use of the machine)

For details on the availability of SmartConnect in different countries and languages as well as further information, go to www.HobartSmartConnect.com



MODULE SELECTION

PRE-WASH ZONES

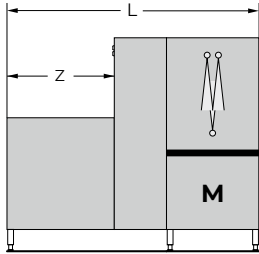

	L	Z
1M	1,450	440
2M	1,750	740
3M	2,050	1,040

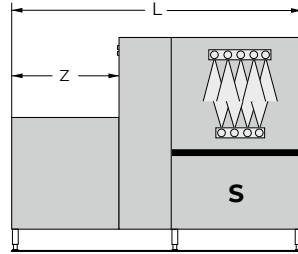

	L	Z
1S	1,700	440
2S	2,000	740
3S	2,300	1,040

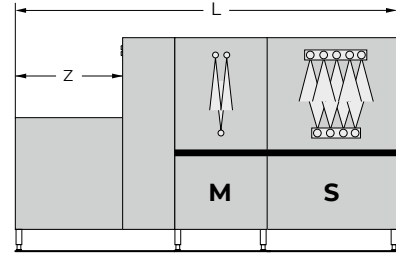

	L	Z
1M-S	2,350	440
2M-S	2,650	740
3M-S	2,950	1,040

MAIN WASH ZONES

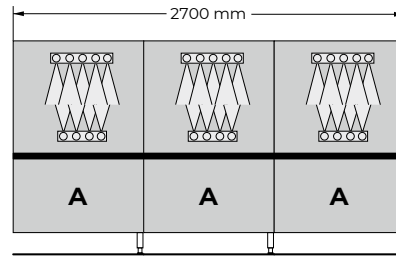
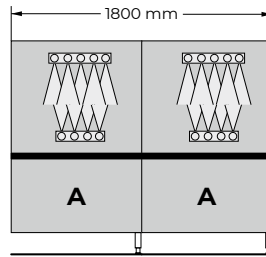
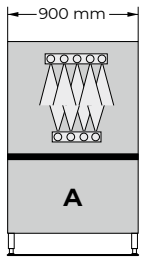

RINSE ZONES

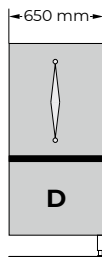
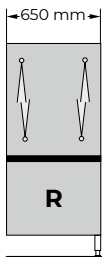

NEUTRAL ZONES

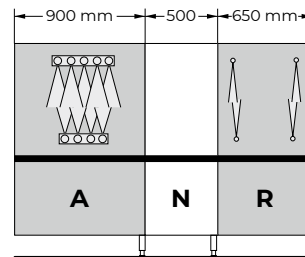
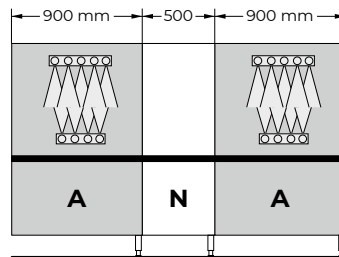

DRYING ZONES

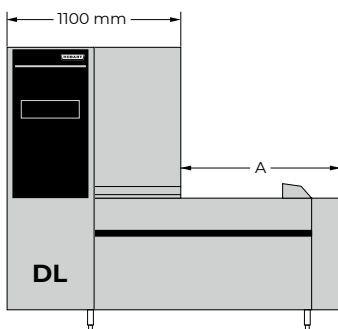

	L	A
DL3	1,100	800
DL4	1,100	1,100
DL5	1,100	1,400

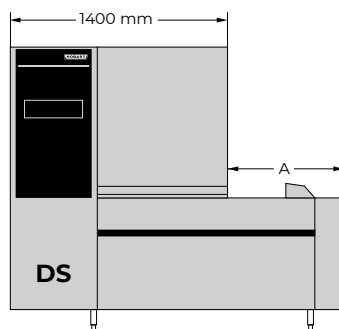

	L	A
DS 4	1,400	800
DS5	1,400	1,100
DS6	1,400	1,400
DS7	1,400	1,700

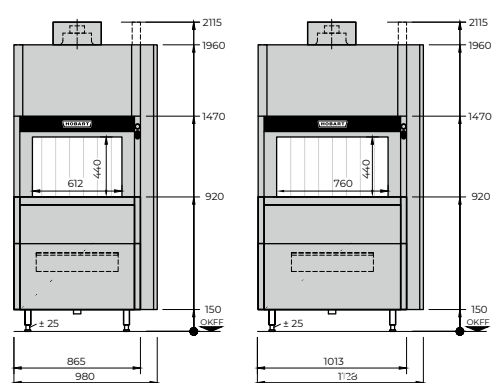

FLOW Line dimensions

Loading width: 612 mm and 760 mm

Loading height: 440 mm

FEATURES

FLOW Line	
SMART VISION CONTROL	
Innovative wash ware detection	●
Performance Package	○
Performance Plus Package	○
Compartment detection	●
HIGH LEVEL OF ECONOMY	
Automatic adjustment of water consumption	●
CLIMATE heat recovery	●
LC detergent saving system	●
CLIMATE-PRO heat pump	○ PREMAX inside
LCI detergent saving system	○ PREMAX inside
LOW-FLOW rinse system	○ PREMAX inside
BEST WASH AND DRYING RESULTS	
ASR ² automatic soil removal	○
Wash system with wide-angle nozzles	●
Triple rinse	○
Conveyor belt with tray support	○
RO-L reverse osmosis system	○
All-around drying system	●
EASY HANDLING	
System check	○
PROTRONIC XL control	○
VISIOTRONIC control	●
USB interface	●
FAST CLEANING	
AUTO-CLEAN self-cleaning system	○
Coded and numbered wash and rinse arms	●
Universal curtain system	●
Colour-coded cleaning assistance	●
Wash arm slider	●
Folding entry section flap	●
Completely moulded tank	●
Strainer drawer in the entry section	●
FLOW LINE TWIN	
Side tray track	○
SMARTCONNECT	
SmartConnect app	●

● Inclusive ○ Optional

* You can find more information on the availability of SmartConnect in different countries and languages as well as further information at www.HobartSmartConnect.com
Free use for 5 years.

HOBART



TECHNICAL DATA

FLOW Line									
PLATE CAPACITY		CONVEYOR SPEED [3]	AVERAGE WATER CONSUMPTION [3]	ENERGY CONSUMPTION in kWh [2]		RECOMMENDED MODEL SELECTION	TOTAL LENGTH	ENTRY ZONE	EXIT ZONE
acc. to DIN	maximum	in m/min	in l/h [1]	(connected value in kW)			in mm	in mm	in mm
				with CLIMATE heat recovery	with CLIMATE-PRO heat pump [4]				
2,570	3,350	1.18	145	24.2 (32.2)	16.7 (22.3)	FLOW Line 1-M-A-R-DL3 FLOW Line 1-M-A-R-DL4 FLOW Line 2-M-A-R-DL3 FLOW Line 2-M-A-R-DL4	4,900 5,200 5,200 5,500	440 440 740 740	800 1,100 800 1,100
2,830	3,690	1.30	145	21.5 (30.7)	16.4 (23.8)	FLOW Line 1-S-A-R-DL3 FLOW Line 1-S-A-R-DL4 FLOW Line 2-S-A-R-DL4 FLOW Line 2-S-A-R-DL5	5,150 5,450 5,750 6,050	440 440 740 740	800 1,100 800 1,100
2,830	3,690	1.30	145	21.5 (30.7)	16.4 (23.8)	FLOW Line 1-S-A-R-DS4 FLOW Line 1-S-A-R-DS5 FLOW Line 2-S-A-R-DS5 FLOW Line 2-S-A-R-DS6	5,450 5,750 6,050 6,350	440 440 740 740	800 1,100 1,100 1,400
3,560	4,620	1.63	145	23 (30.7)	17.8 (23.8)	FLOW Line 1-M-S-A-R-DS5 FLOW Line 2-M-S-A-R-DS5 FLOW Line 2-M-S-A-R-DS6 FLOW Line 2-M-S-A-R-DS7	6,400 6,700 7,000 7,300	440 740 740 740	1,100 1,100 1,400 1,700
3,820	4,960	1.75	165	26.2 (39.7)	20.7 (31.3)	FLOW Line-2-S-A-A-R-DS5 FLOW Line-2-S-A-A-R-DS6 FLOW Line-2-S-A-A-R-DS7	6,950 7,250 7,550	740 740 740	1,100 1,400 1,700
4,540	5,900	2.08	165	26.2 (39.7)	20.6 (31.3)	FLOW Line-2-M-S-A-A-R-DS5 FLOW Line-2-M-S-A-A-R-DS6 FLOW Line-2-M-S-A-A-R-DS7	7,600 7,900 8,200	740 740 740	1,100 1,400 1,700
4,800	6,240	2.20	170	31.2 (47.2)	23.6 (35.8)	FLOW Line 2-S-A-A-A-R-DS5 FLOW Line 2-S-A-A-A-R-DS6 FLOW Line 2-S-A-A-A-R-DS7	7,850 8,150 8,450	740 740 740	1,100 1,400 1,700
5,520	7,180	2.53	170	31.2 (47.2)	23.6 (35.8)	FLOW Line 2-M-S-A-A-A-R-DS5 FLOW Line 2-M-S-A-A-A-R-DS6 FLOW Line 2-M-S-A-A-A-R-DS7	8,500 8,800 9,100	740 740 740	1,100 1,400 1,700

All values are for machines with a passage width of 612 mm.

[1] Fresh-water consumption rates under optimum conditions (rates at a specific customer's may differ)

[2] Average rate with an exemplary set of covers and type of business

[3] For hygienic rinse result according to DIN EN 17735

[4] Machines with heat pump contain up to 5.1 kg (3.22 t CO2-equivalent) of the refrigerant R531A (GWP 631)



OUR VISION

Wash without water

Intensive market research has shown that our customers expect warewashing technology that combines efficiency with optimal performance. We are focused on meeting these demands and they form the foundation of our vision to "wash without water". This vision is our continuous incentive to break new ground in order to constantly reduce the consumption of water, energy and chemicals. We continue pursuing this goal methodically and with the most innovative engineering. Indeed, we already know that:

» When the first machine is finally capable of washing without water, it will be a HOBART. «

THE COMPANY

We are HOBART

HOBART is the world market leader for commercial warewashing technology and a well known manufacturer of cooking, food preparation, and environmental technology. Established in 1897 in Troy, Ohio, today HOBART employs more than 6,900 employees around the world. At our manufacturing plant in Offenburg, Germany, HOBART develops, produces, and distributes warewashing technology worldwide. The hotel and catering trade, cafeterias, bakeries and butcher shops, supermarkets, airlines, cruise ships, automotive suppliers, research centres and pharmaceutical companies all over the world swear by our innovative products, which are considered to be economical and ecological market leaders.



HOBART

LET'S MAKE IT
HAPPEN!

MADE IN GERMANY

We provide this promise of quality to our customers, and it represents our personal standard upheld by all our staff at HOBART.



smartclean 
smartgreen 

OUR FOCUS

Innovative – economical – sustainable

This is our philosophy. To us, **innovation** means continuously setting new standards in technology, combined with real added value for the customer. Our group's Technological Centre, and our own Innovation Centre for Warewashing Technology at our headquarters in Germany, make this possible. With this combined innovative power we create highly efficient products which continuously confirm our status as technological leader. To be **economical** means to set standards in terms of the lowest operating costs, minimal use of resources and to revolutionise the market continuously. To be **sustainable** means responsible handling of resources and a sustainable energy policy. This applies not only to the product in use, but in general to all areas of the organisation, such as purchasing or manufacturing.

HOBART

Competent – fast – reliable

HOBART offers a worldwide service partner network for all products. These technicians always carry out maintenance and repair work competently, quickly and reliably. Thanks to regular trainings and many years of experience, they have detailed product knowledge and will help you so that you can focus on your business. Good to know: The lifetime service warranty also guarantees the availability of all spare parts for the entire lifetime of your machine.

HOBART

DEUTSCHLAND/ÖSTERREICH

HOBART GMBH

Robert-Bosch-Straße 17 | 77656 Offenburg
Tel.: +49 781 600-0 | info@hobart.de
www.hobart.de



Werkskundendienst +49 800 600 1313
für Österreich +43 820 240 599

Zentraler Verkauf +49 180 300 0068

SCHWEIZ

GEHRIG GROUP AG

Bäulerwisenstrasse 1 | 8152 Glattbrugg
Tel.: +41 43 211 56-56
info@gehriggroup.ch
www.gehriggroup.ch

FRANCE

COMPAGNIE HOBART

ZI PARIS EST - Allée du 1er Mai - B.P. 68
77312 MARNE LA VALLEE Cedex 2
Téléphone: +33 1 64 11 60 00
contact@hobart.fr
www.hobart.fr

UNITED KINGDOM

HOBART UK

Southgate Way | Orton Southgate
Peterborough | PE2 6GN
Phone: +44 844 888 7777
customer.support@hobartuk.com
www.hobartuk.com

BELGIUM

HOBART FOSTER BELGIUM

Industriestraat 6 | 1910 Kampenhout
Phone: +32 16 60 60 40
sales@hobart.be
www.hobart.be

NEDERLAND

HOBART NEDERLAND B.V.

Pompmolenaar 12 | 3447GK Woerden
Tel.: +31 348 46 26 26
info@hobart.nl | www.hobart.nl

NORGE

HOBART NORGE

Gamle Drammensvei 120 A | 1363 HØVIK
Tel.: +47 67 10 98 00
post@hobart.no | www.hobart.no

SVERIGE

HOBART SCANDINAVIA APS

Varuvägen 9 | 125 30 Älvsjö
Tel.: +46 8 584 50 920
info@hobart.se | www.hobart.se

DANMARK

HOBART SCANDINAVIA APS

Håndværkerbyen 27 | 2670 Greve
Tel.: +45 43 90 50 12
salg@hobart.dk | www.hobart.dk

AUSTRALIA

HOBART FOOD EQUIPMENT

Unit 1/2 Picken Street | Silverwater NSW | 2128
Tel.: +61 2 9714 0200
www.hobartfood.com.au

SPAIN

HOBART ESPAÑA

DIVISION DE ITW ESPAÑA, S.L.U.

Ctra de Ribes KM 31,7
08520 Les Franqueses del Vallés, Barcelona
Phone +34 938 605 020
info@hobart.es | www.hobart.es

KOREA

HOBART KOREA LLC

7th Floor | Woonsan Bldg | 108 | Bangi-dong
Songpa-gu | Seoul 138-050
Phone: +82 2 34 43 69 01
contact@hobart.co.kr
www.hobart.co.kr

JAPAN

HOBART (JAPAN) K.K.

Suzunaka Building Omori
6-16-16 Minami-Oi | Shinagawa-ku | Tokyo 140-0013
Phone: +81 3 5767 8670
info@hobart.co.jp | www.hobart.co.jp

SINGAPORE

HOBART INTERNATIONAL (S) PTE LTD

158 | Kallang Way | #06-03/05
Singapore 349245
Phone: +65 6846 7117
enquiry@hobart.com.sg
www.hobart.com.sg

THAILAND

HOBART (THAILAND)

43 Thai CC Tower Building | 31st FL
Room No. 310-311 | South Sathorn Rd.
Yannawa | Sathorn | Bangkok | 10120
Phone: +66 2 675 6279 81 | enquiry@hobartthailand.com
www.hobartthailand.com

OTHER COUNTRIES

HOBART GMBH

Robert-Bosch-Straße 17 | 77656 Offenburg | Germany
Phone: +49 781 600-2820
info-export@hobart.de
www.hobart-export.com

Die Angaben in diesem Prospekt beruhen auf dem Stand 02/2025. Technische Änderungen oder Änderungen der Ausführung bleiben vorbehalten.

The details given in this brochure are correct as of 02/2025. We reserve the right to make technical or design modifications.

Document non contractuel. Les indications de ce prospectus sont conformes à la mise à jour de 02/2025. Nous nous réservons le droit de modifier les données ou les configurations techniques de nos machines.

